

WiFi & RF RGB/RGBW SPI LED Controller

- Multi-pixel RGB/RGBW LED strip controller with SPI signal output, Tuya smart APP cloud control.
- Voice control, support for Amazon Alexa, Google Assistant, Tmall Genie and Xiaodu voice assistant.
- Compatible with RGB or RGBW LED strips with 49 kinds chip, the chip type and R/G/B/W color sequence can be set through the APP.
Compatible chip: TM1809(default), TM1804, TM1812, UCS1903, UCS1909, UCS1912, SK6813, UCS2903, UCS2909, UCS2912, WS2811, WS2812, WS2813, WS2815, SM16703P, TM1803, TM1829, TLS3001, TLS3002, GW6205, MBI6120, TM1814B(RGBW), SK6812(RGBW), WS2813(RGBW), WS2814(RGBW), UCS8904B(RGBW), LPD6803, LPD1101, D705, UCS6909, UCS6912, LPD8803, LPD8806, WS2801, WS2803, P9813, SK9822, TM1914A, GS8206, GS8208, UCS2904, SM16804, SM16825, SM16714(RGBW), UCS2603, UCS5603, SM16714D, UCS7604(RGBW), UCS7804(RGBW).
- Painted segment color mixing: full color filling, color pencil segment painting, eraser segment light off.
- Rich dynamic effects: 44 default and 10+ custom dynamic scenarios, 16 variations.
- 3 APP music rhythms.
- Match with RF 2.4G RGB/RGBW remote control optional.



CE RoHS RED

Technical Parameters

Input and Output		Safety and EMC		Environment	
Input voltage	5-24VDC	EMC standard	EN 62479:2010 ETSI EN 301 489-1 V2.2.3 ETSI EN 301 489-17 V3.2.4	Operation temperature	Ta: -30°C ~ +55°C
Input Current	8A	Safety standard	EN 61347-1:2015+A1:2021 EN 61347-2-13:2014+A1:2017	Case temperature (Max.)	Tc: +65°C
Input signal	WiFi + RF 2.4GHz	Radio Equipment	ETSI EN 300 328 V2.2.2	IP rating	IP20
Output signal	SPI(TTL) x 2	Certification	CE RED	Package	
Scenario Mode	44 default and 10+ customizations	Warranty		Size	L120 x W43 x H27mm
Pixel Dots	MAX.1000	Warranty	5 years	Gross weight	0.066kg

Mechanical Structures and Installations

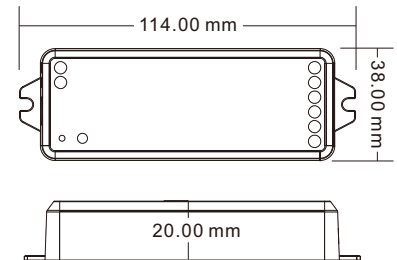
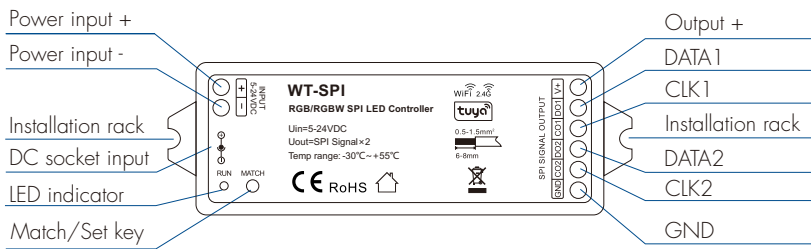

System Wiring

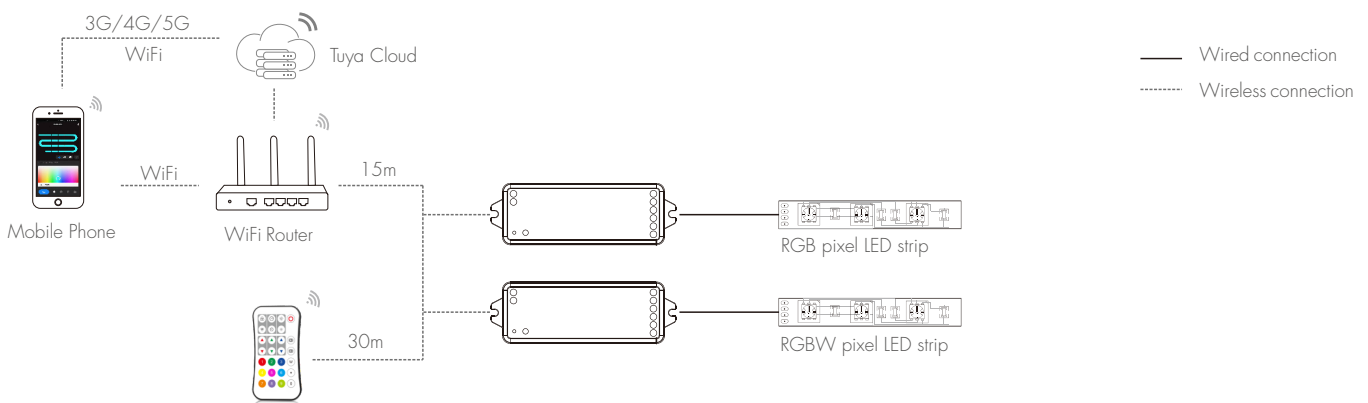

Note:

1. The above distance is measured in spacious (no obstacle) environment, Please refer to the actual test distance before installation.
2. Please check if the WiFi router net in 2.4G band, the 5G band is not available, and do not hide your router network.
3. Please keep the distance between WT-SPI devices and router close, and check the WiFi signals.
4. WiFi signal strength detection: open the main interface of social security, click enter the device interface, click "check device network" for testing.

Wiring Diagram

- WT-SPI connect with SPI spotlights (TM1803)

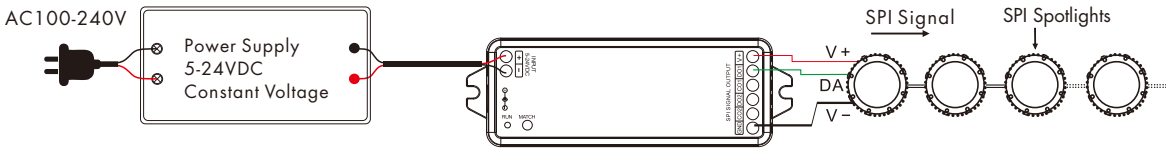

- WT-SPI connect with one SPI pixel strips (WS2801)

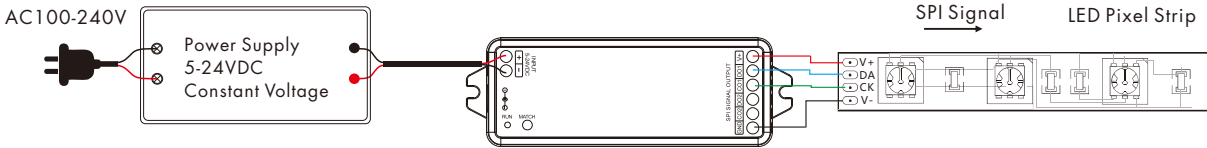

- WiFi-SPI connect with SPI digital light tube (TM1809)

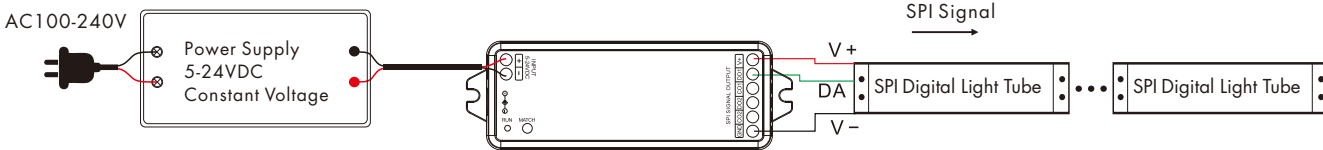

- WT-SPI connect with multiple SPI pixel strips (LED strip load over 8A)

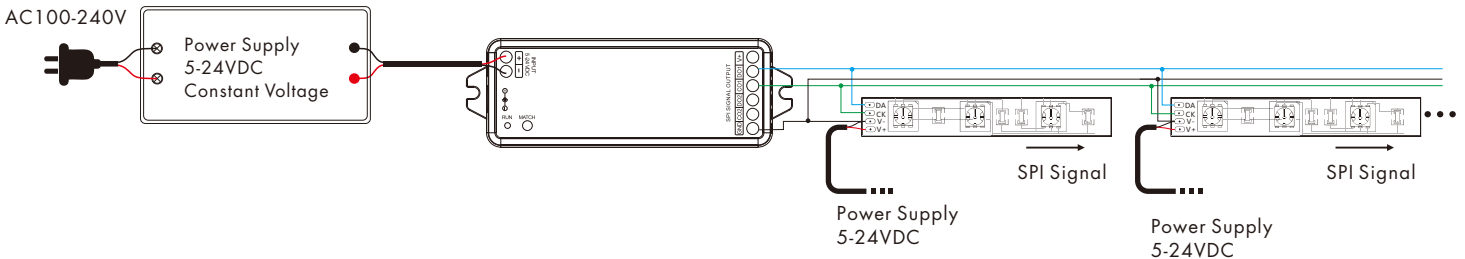

Wire Preparation:

1. The wiring can be solid or stranded with a cross-sectional area of 0.5 to 1.5 mm².

Conventional 1mm² can withstand 10A output current.

2. When wiring is installed, the terminals must be tightened.

If they are not tightened, the contact point resistance will be too high and the terminals will easily burn due to heat when used at full load for a long time.

0.5-1.5mm²

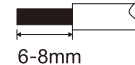

6-8mm



Installation Precautions:

1. If the SPI LED strip is a single-wire control method, the DATA and CLK signal line outputs of the controller are same, and one controller can connect 4 LED strips.
2. When the load of the light strip exceeds 8A, the light strip needs to be powered by another power supply (the light strip and the power supply must share the same ground), and only the DATA/CLK and GND lines are connected between the controller and the light strip.
3. The output power of the constant voltage power supply is at least 1.2 times that of the output load (light strip), otherwise the full power output of the load will easily cause the lights to flicker or shake automatically.
4. The voltage of the power supply needs to be the same as the voltage of the light strip to avoid the phenomenon of the light strip not being lit or slightly lit.
5. When installing, the length of the signal line (DATA/CLK) needs to be ≤ 10 metres, and if it exceeds 10 metres, it needs to be connected to an SPI signal amplifier (common ground) for signal amplification, to avoid signal interference due to the line being too long.
6. When installing, the SPI signal lines (DATA, CLK) need to be separated from the strong power (100~240VAC) lines at a distance of ≥1.5cm to avoid the magnetic field generated by the strong power from interfering with the signal transmission.
7. Each signal output port (DATA/CLK) can only be connected to one set of light strips.
8. The light strip is always on without control, it may be that the signal line (DATA/CLK) is open or the chip of the light strip is damaged, it is recommended to replace the signal line or the light strip.

Match RF Remote Control

Match: Short press on the match key, immediately press on/off key of the remote. The LED indicator fast flash a few times means match is successful.

Delete: Press and hold match key for 10s to delete all match, The LED indicator fast flash a few times means all matched remotes were deleted.

Tuya smart APP Network Connection

Push twice Match key fastly, or press and hold Match key for 2s:
clear previous network connection, enter Smart config mode, LED indicator flash fastly.

Press and hold Match key for 5s:
Clear previous network connection, enter AP config mode, LED indicator flash slowly.
If smart config failed, please try AP config.

If Tuya smart APP network connection succeed, the RUN LED indicator will stop flash, and in Tuya smart APP, you can find WT-SPI device .

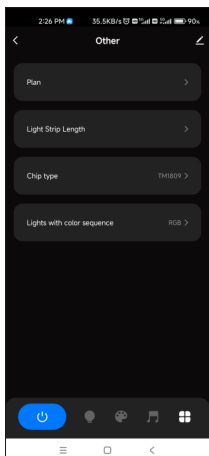

Other interface

For the first time use, set LED strip length, chip type and color sequence.

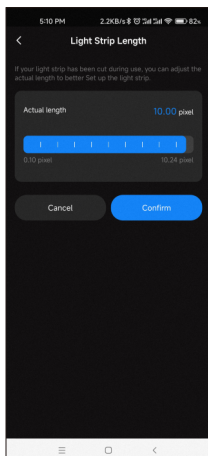

Light Strip Length interface

Strip length setting:
Select the appropriate number of pixels according to the actual length of the strip, 10 -1000.

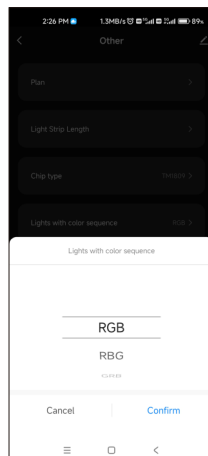

Lights with color sequence interface

Select the corresponding R/G/B/W sequence according to the color sequence of the light strip. (RGB, RBG, GRB, GBR, BRG, BGR, RGBW, RBGW, GRBW, GBRW, GBRWV, BRGW, BGRWV, WRGB, WRBG, WGRB, WGBR, WBRG, WBGR)

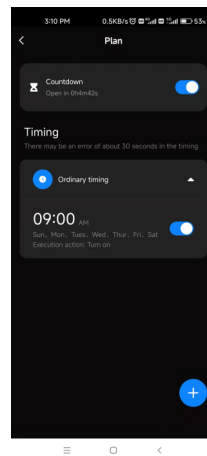

Plan interface

Countdown:
Customize the countdown time (Max.24 hours) to perform the on/off action.
Timer: Customize multiple times to perform the on/off light action.

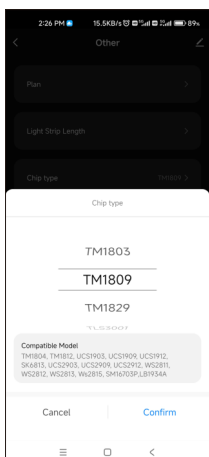

Chip type interface

Select the corresponding chip according to the chip type of the light strip.

Chip Type	Compatible Chip
TM1803	
TM1809	TM1804, TM1812, UCS1903, UCS1909, UCS1912, SK6813, UCS2903, UCS2909, UCS2912, WS2811, WS2812, WS2813, WS2815, SM16703P
TM1829	
TLS3001	TLS3002
GW6205	
MBI6120	
TM1814B(RGBW)	
SK6812(RGBW)	WS2813(RGBW), WS2814(RGBW)
UCS8904B(RGBW)	
LPD6803	LPD1101, D705, UCS6909, UCS6912
LPD8803	LPD8806
WS2801	WS2803
P9813	
SK9822	
TM1914A	
GS8206	GS8208
UCS2904	
SM16804	
SM16825	
SM16714(RGBW)	
UCS5603	
UCS2603	
SM16714D	
UCS7604(RGBW)	
UCS7804(RGBW)	

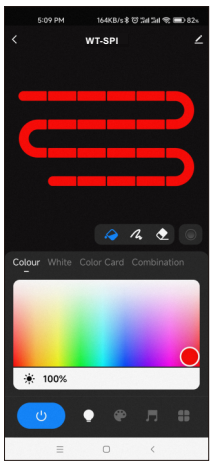

Colour:
Touch the color rectangle to adjust color and saturation. Touch the brightness slide to adjust brightness.

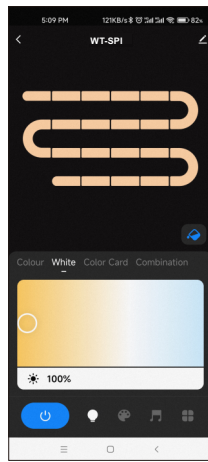

White:
Touch the color rectangle to adjust color temperature. Touch the brightness slide to adjust brightness.

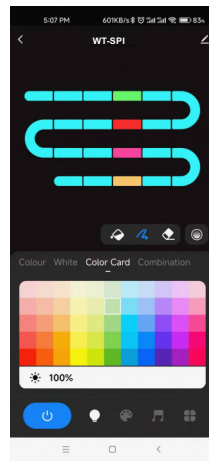

Color Card:
Touch the color card array to select many different colors. Touch the brightness slide to adjust brightness.

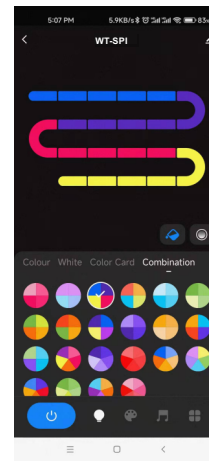

Combination:
Select a proportional distribution of multi-color circle, evenly distribute these colors on the LED strip.



Color Fill: Change the color of the full segment of the LED strip.



Color pen: change the color of a single segment of the LED strip.



Eraser: Erase the color of a single segment of the LED strip, i.e., turn off the light.



Color transition: When there are multiple colors in the LED strip, you can set to turn on or off the color segment gradient transition.

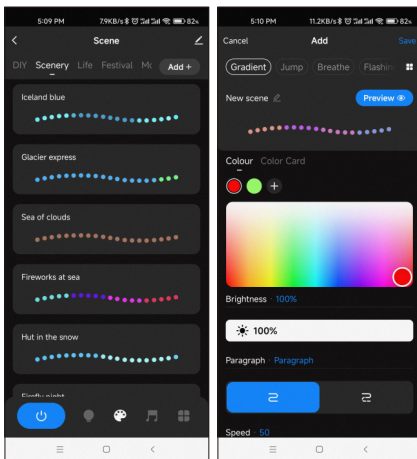

Scene interface

44 predefined scenarios and 10+ custom dynamic scenarios selectable. The custom scenarios can select 16 types variations (fade, jump, breath, flash, flow, rainbow, shooting star, pile-up, floating down, chasing light, floating, flashing, bouncing, shuttle, chaotic flashing, open and close), the 1-8 colors, full or segment control, forward or reverse motion direction, adjustable brightness and speed.

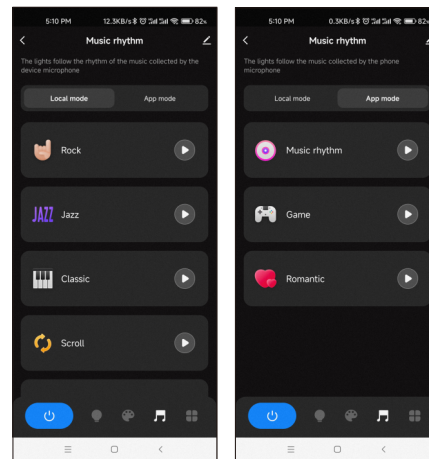

Music rhythm interface

6 local music modes (rock, jazz, classical, rolling, energy, spectrum) selectable. 3 APP modes (music rhythm, game, romance) selectable. Adjustable sensitivity of the received sound. The light follows the rhythm according to the music collected by the phone microphone. Note: the controller only supports App mode.

Notes.

1. In APP, a light strip is fixed with 20 segments, strip length (total number of pixel points) ÷ 20 segments = number of pixel points per segment.
2. The maximum length of the light strip is 1000 pixels, for example, a light strip of 5 meters long with 60 pixels per meter, you can set the length to 300 pixels. The whole light strip is divided into 20 segments, each segment has 15 pixels.
3. When the light strip length is less than or equal to 20 pixels, for example, 10-20, each pixel sequentially corresponds to each segment from the beginning.
4. When the light strip length is not an integer multiple of 20, the remainder of the strip will display the color of the last segment.
5. When the actual light strip length is not an integer multiple of 20, it is recommended to set the length longer and increase the value to a multiple of 20.
6. When the set of the light strip length is less than the actual length, the back part of the light strip can not be controlled.
7. When the selected dynamic mode cycle running interval is too long, please reset the correct pixel length.
8. When the static or dynamic mode color display is not consistent with the APP interface, please re-select the light strip color sequence.

Restore factory default setting

Factory default parameters: RGB light type, pixel length 300, TM1809 chip type.

1. Long press the match key for 15s, restore the factory default parameter settings, and set RGB color light and W white light can be turned on at the same time (When changing the chip type to RGBW lighting).
2. Long press the match key for 20s, restore the factory default parameter settings, and set RGB color light and W white light can not be turned on at the same time (When changing the chip type to RGBW lighting).